

instruction

1027 05 13 42
211/2

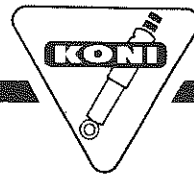
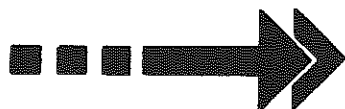
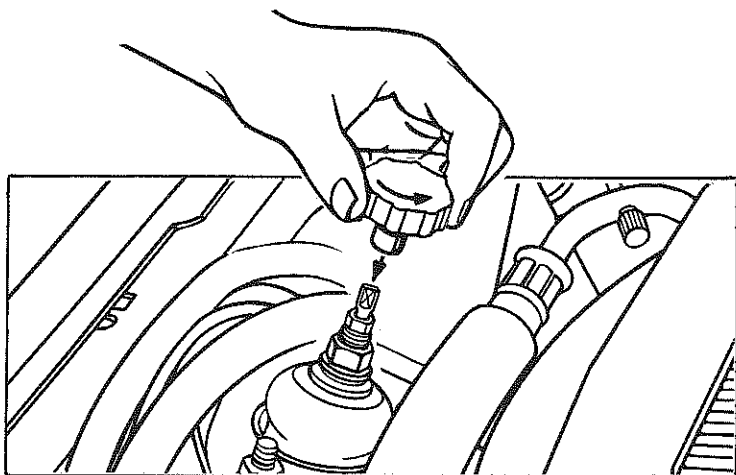
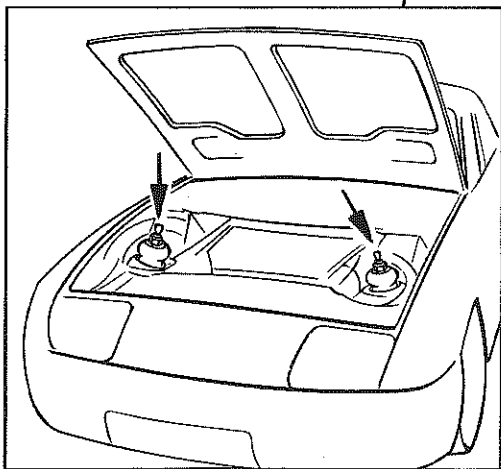
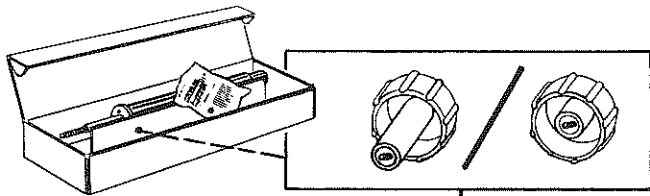
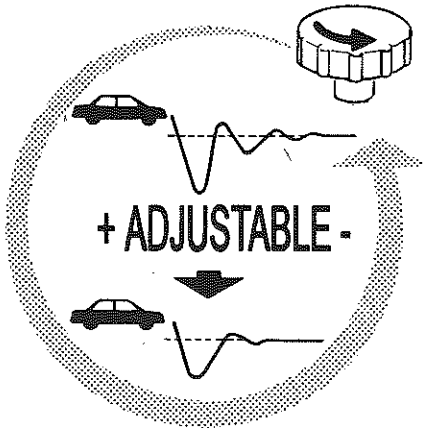

instruction

1027 05 13 42
211/2

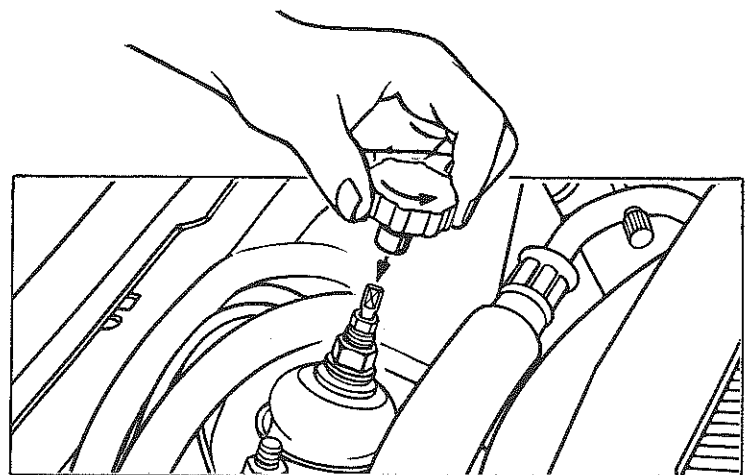
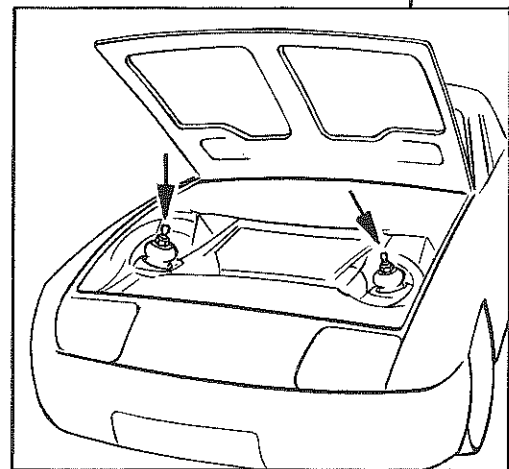
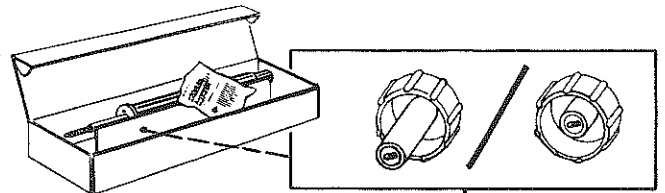
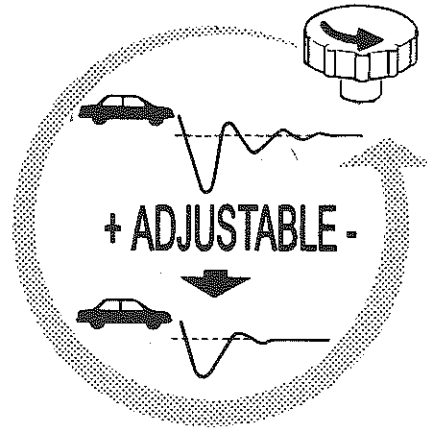

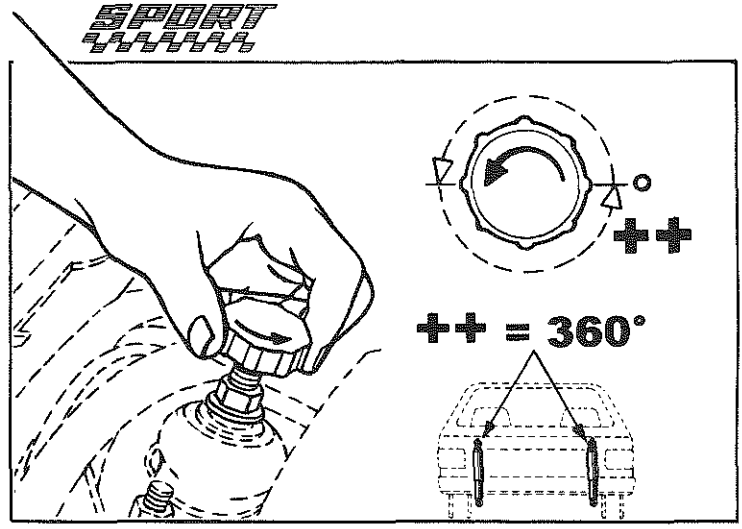
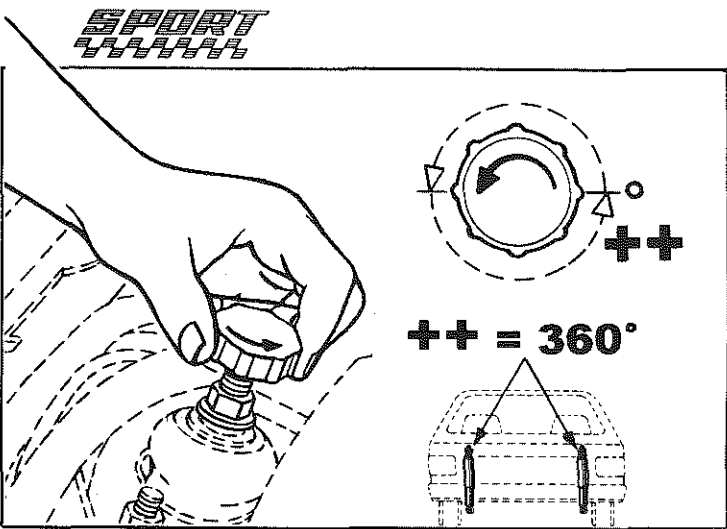
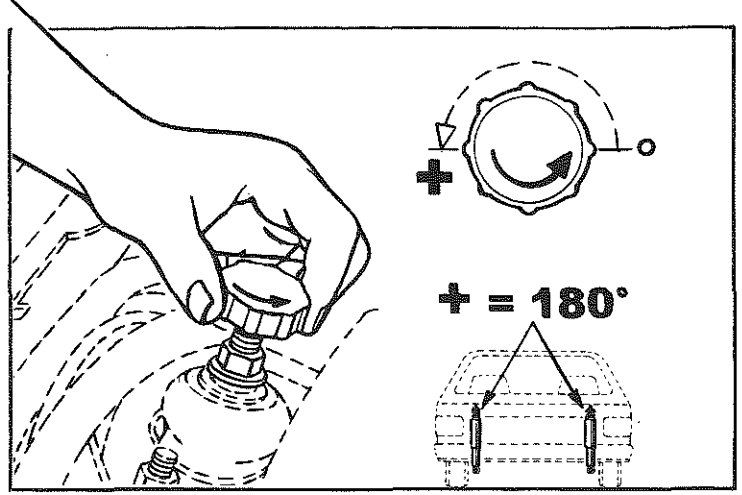
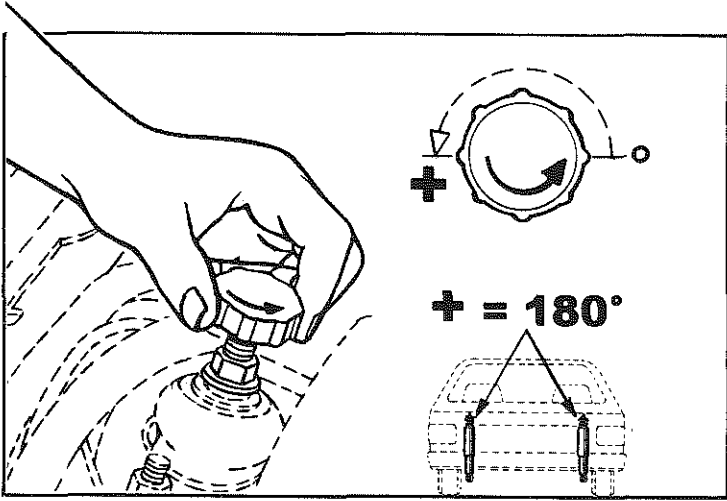

++++ = MAX. 720°

++++ = MAX. 720°

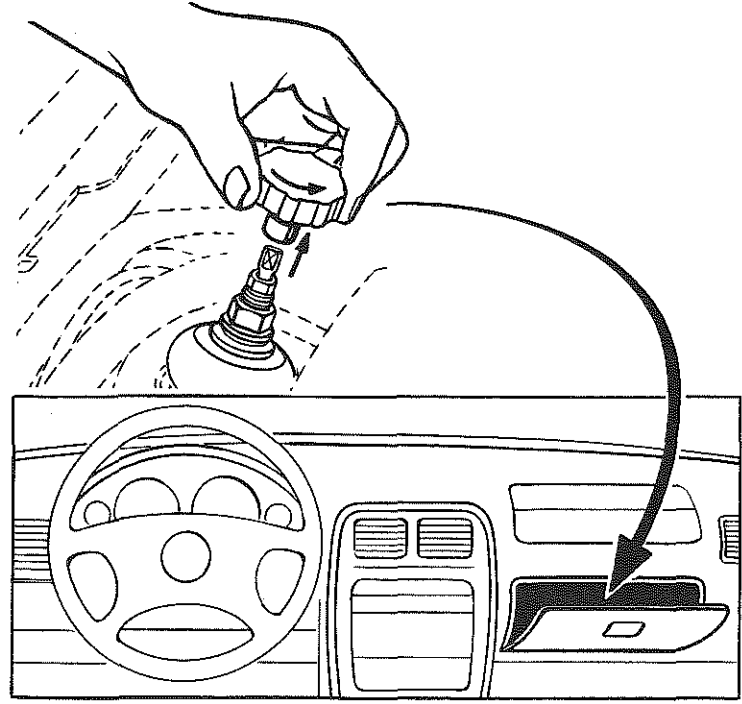
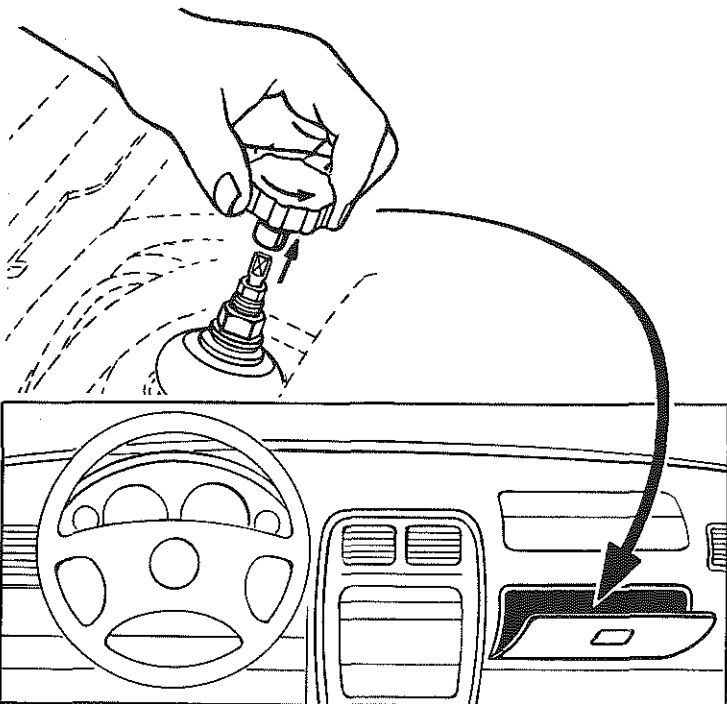

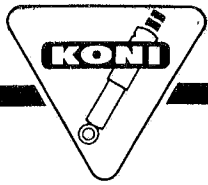

instruction

1027 05 11 56
301/2

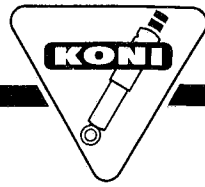
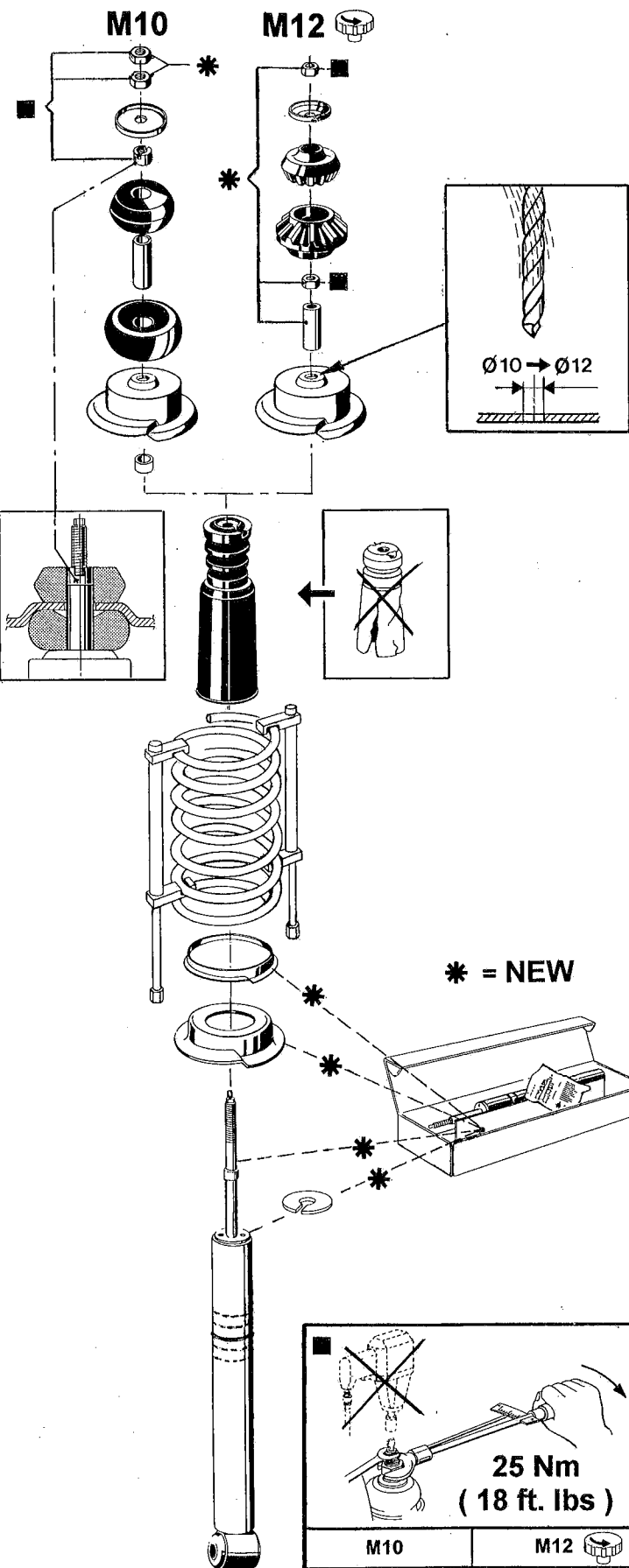

instruction

1027 05 11 56
301/2

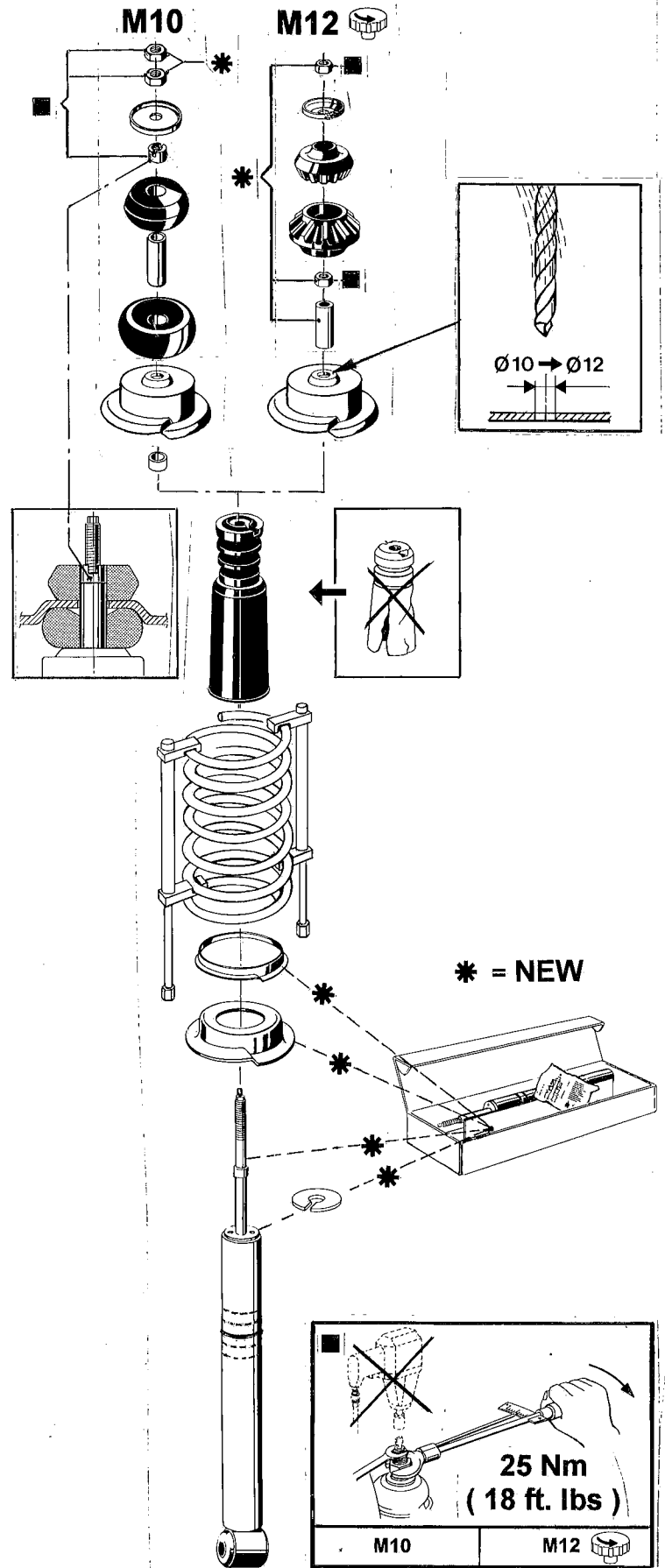

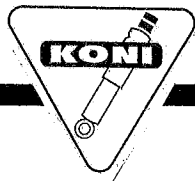

instruction

1027 05 17 76
107 /2

